



RDMZ90/Z80/X70/X60/S30/S10

Introduction

For enjoying the riding, please follow instructions in this leaflet. Please contact your local dealer if any problems are experienced with the product.

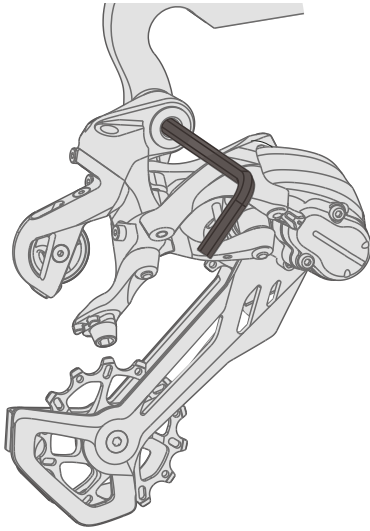

Installation

1. Install the rear derailleur to the frame :
Tighten pivot screw to 8~10 Nm using 5mm Allen key.

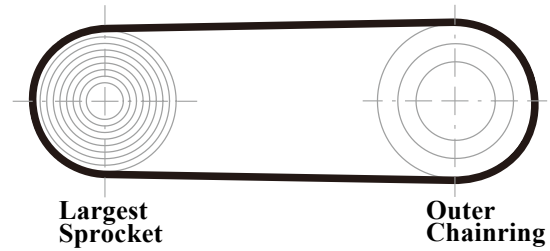

2. Chain length determination :
Setting the chain onto the largest sprocket of freewheel and the largest chainring of front chainwheel. Add links of chain to set the length of the chain.



50T , 46T +  (4 links)
42T , 40T +  (2 links)

3. Put the cable into the screw and tight to 4~6 Nm using 5mm Allen key. Then trim the cable to fit.

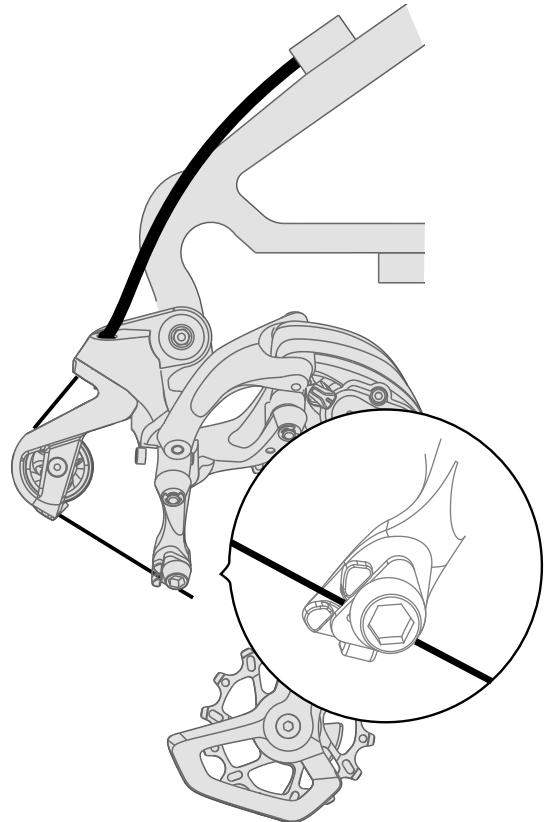
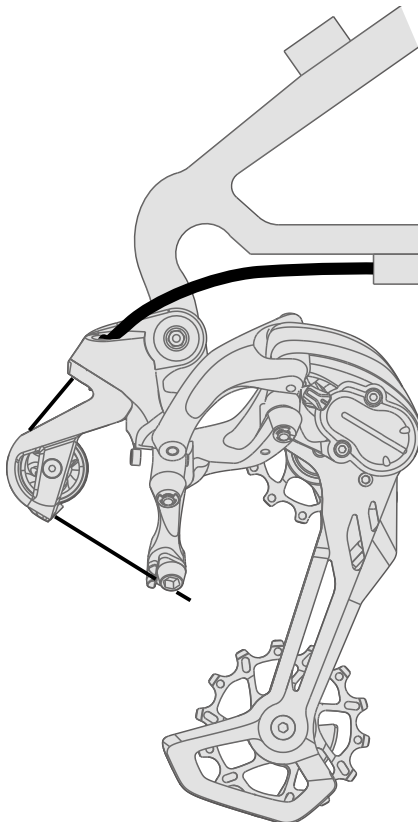

4. Adjust the high and low adjustment screw for setting the high and low limit.

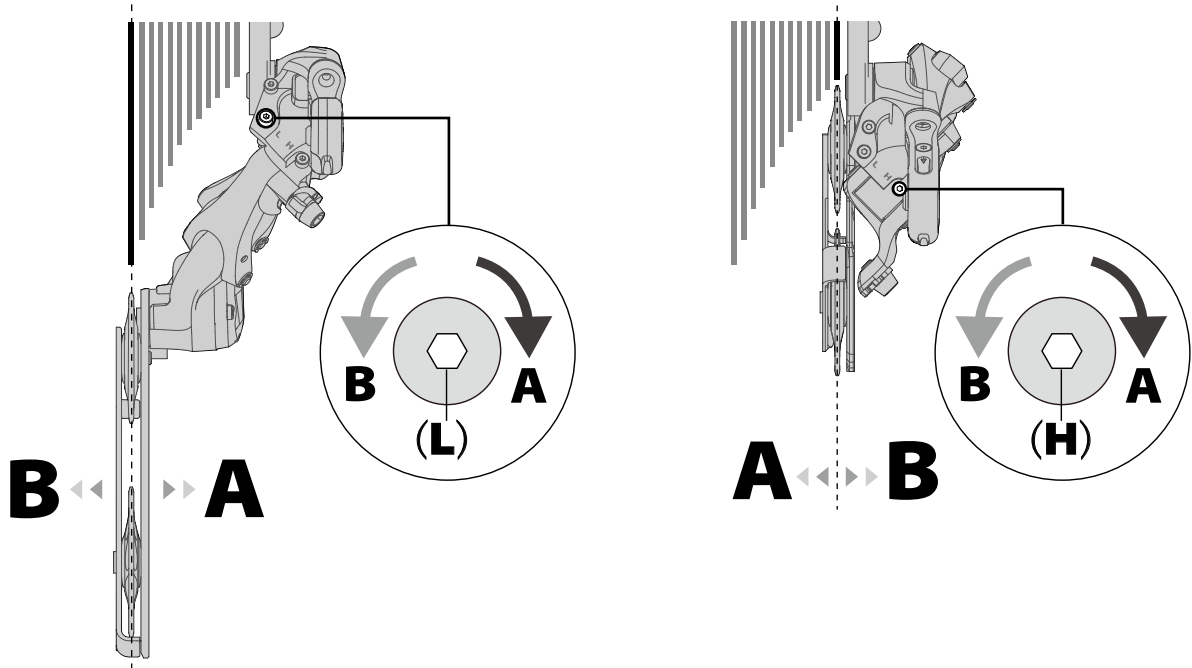

5. Set the rear derailleur on the largest sprocket adjust the end adjust screw with a 2mm Allen key so that the clearance between the tip of the guide pulley and the tip of the largest sprocket is within the range.

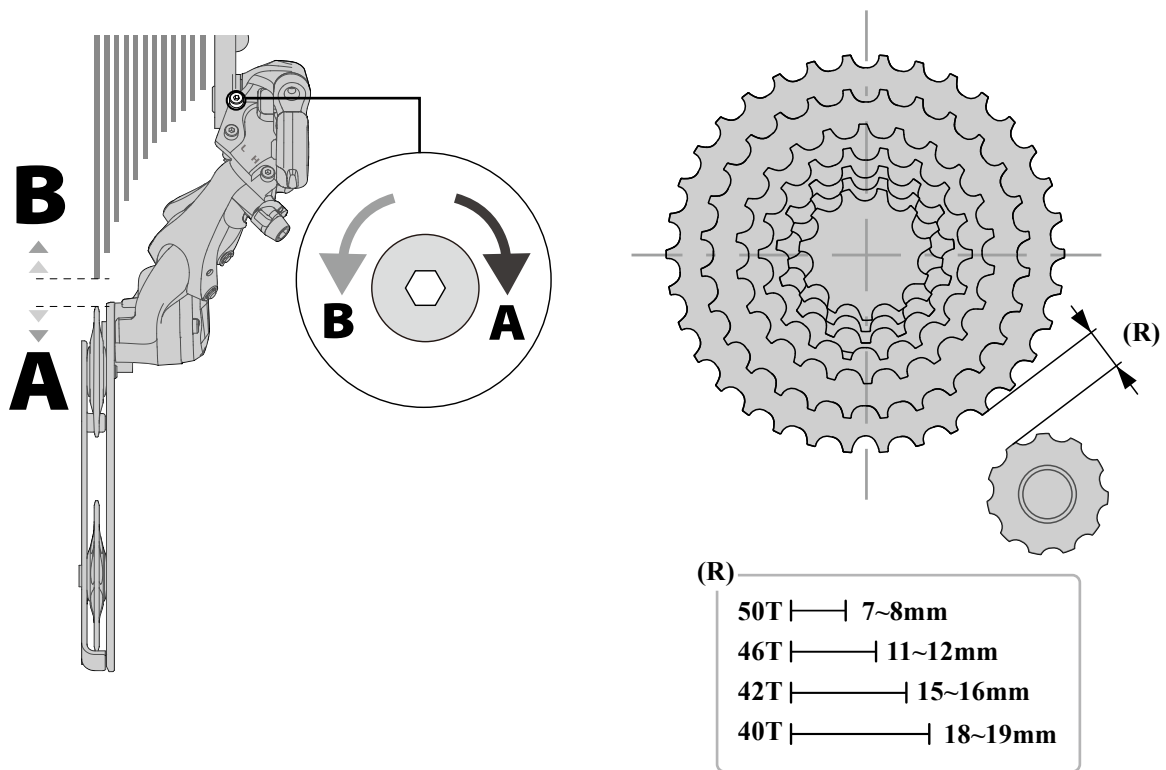

6. Make sure that the lever switch is in the ON position. If the lever switch is in the OFF position, move it to the ON position.

